

Variant 1.

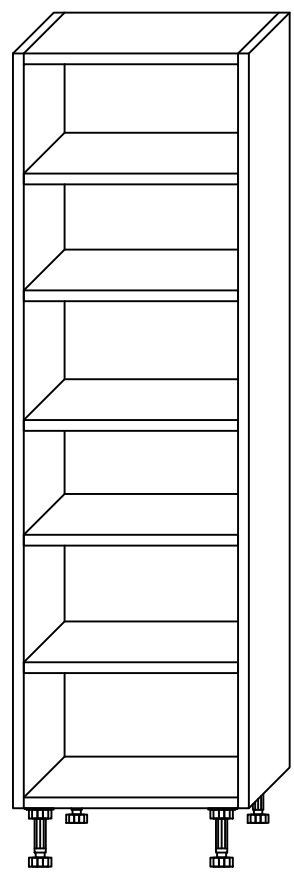

A x16	B x8	C x8	D x8
F x30	G x4	I x4	J x8
			$\varnothing 5 / \varnothing 13\text{mm}$
L x2	L.1 x8	Q.1 x32	H x8
		4x16mm 	

Variant 2-6

L.1 x12	Q.1 x24
	4x16mm

1.

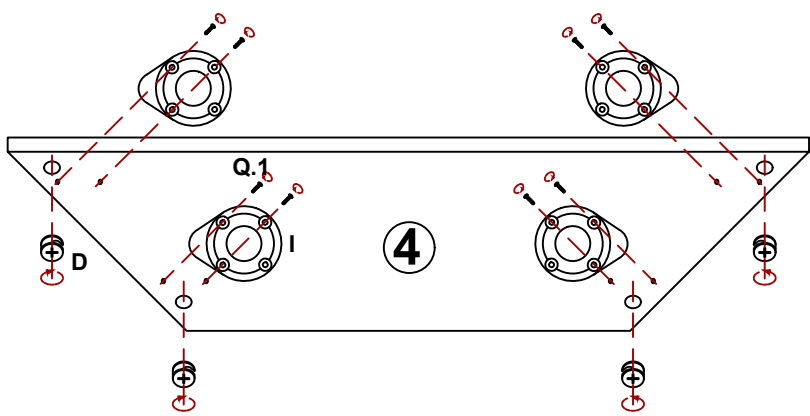
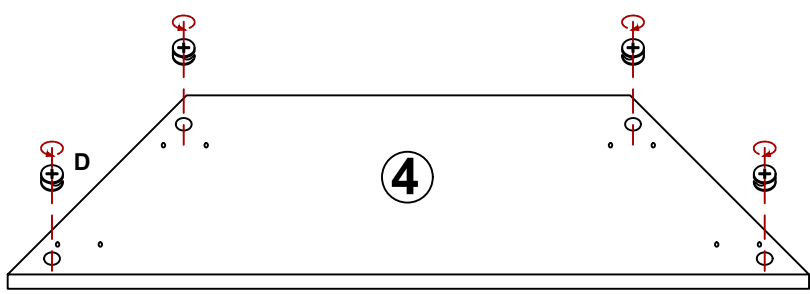

1.

2.

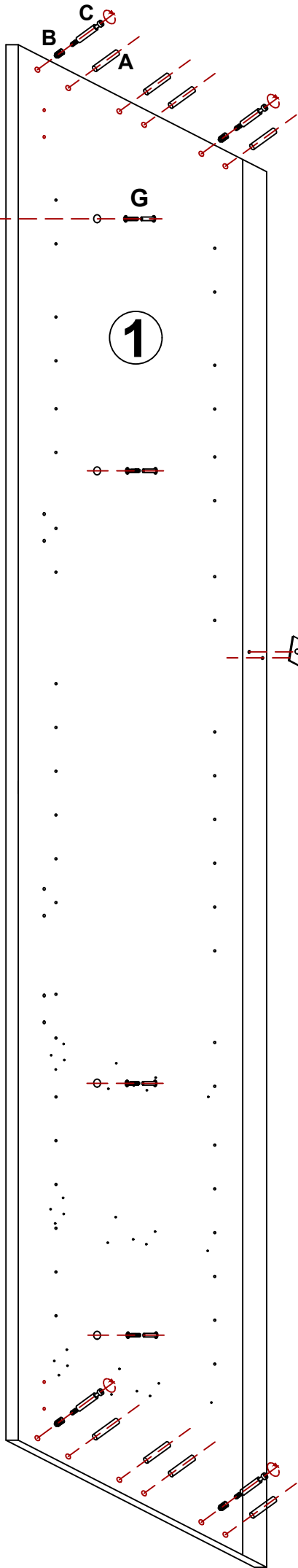

1

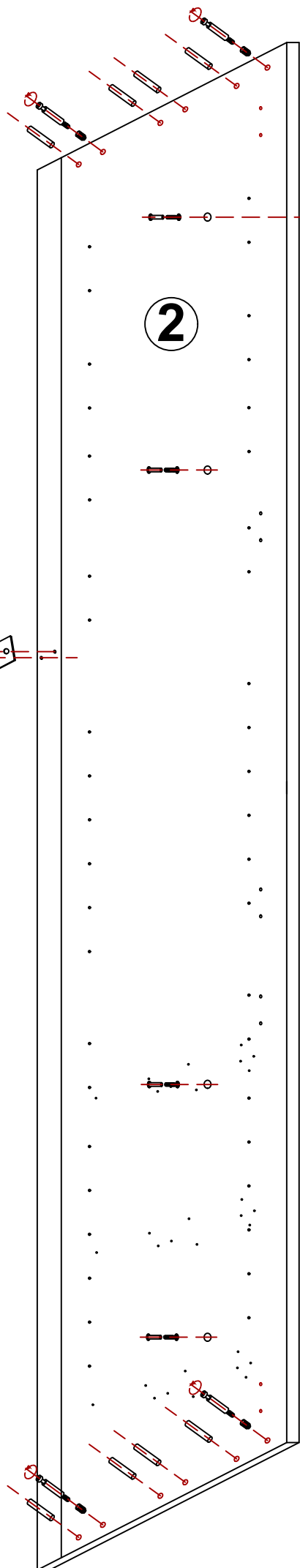

2

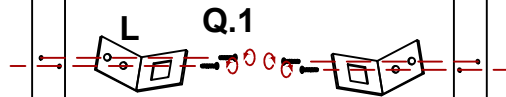

2.

Variant 1.

3.

4.

5.

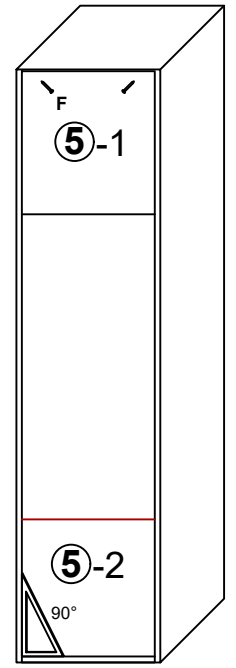
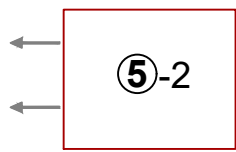
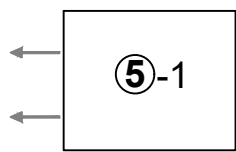
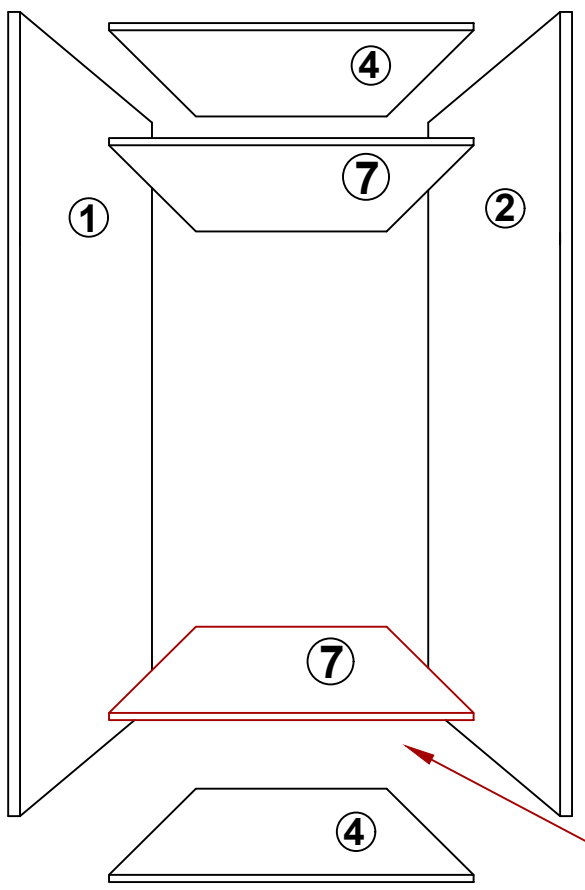
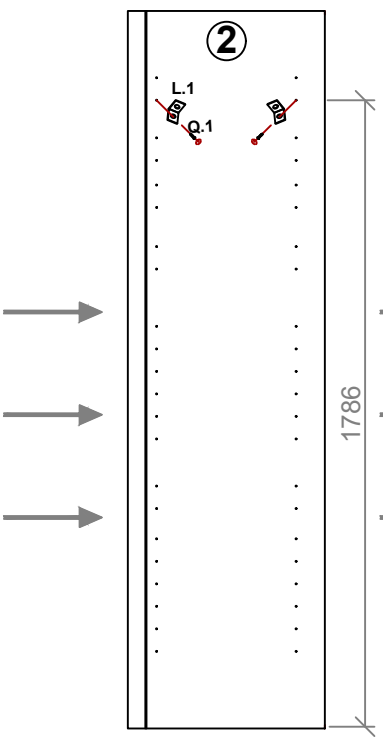
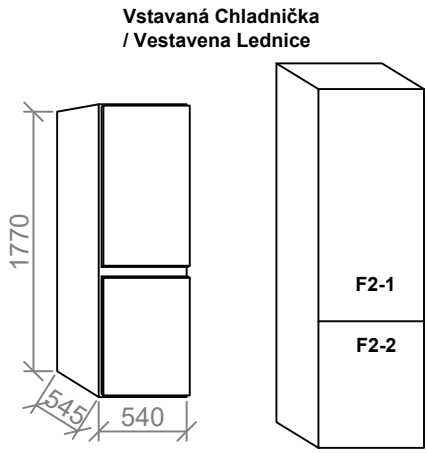

Pri použití iného typu, potreba upraviť vrtanie police pre horné uchytenie chladničky, prípadne aj pre spodnú policu.

Při použití jiného typu, potřeba upravit vrtání police pro horní uchytení chladničky, případně i pro spodní polici.

*Voliteľné.
Voliteľné.*

Variant 2.

3.

4.

5.

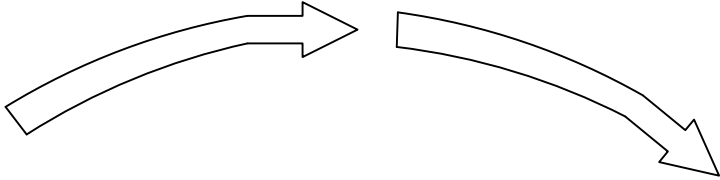
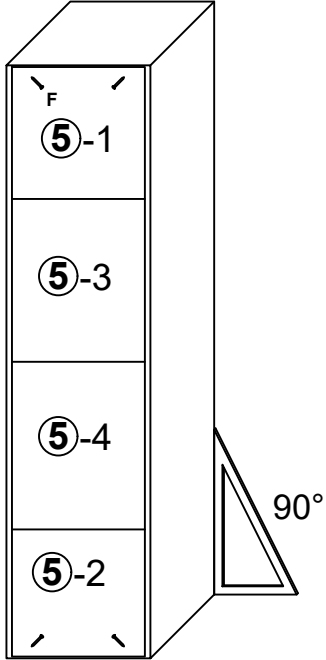
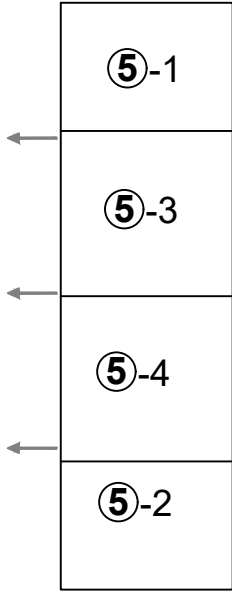
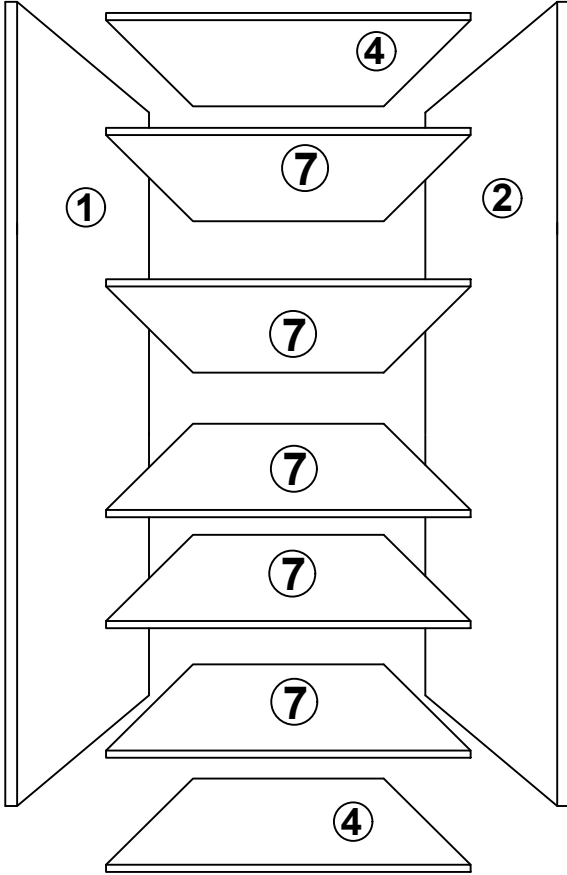
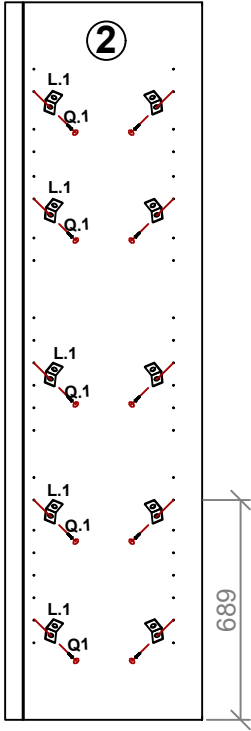
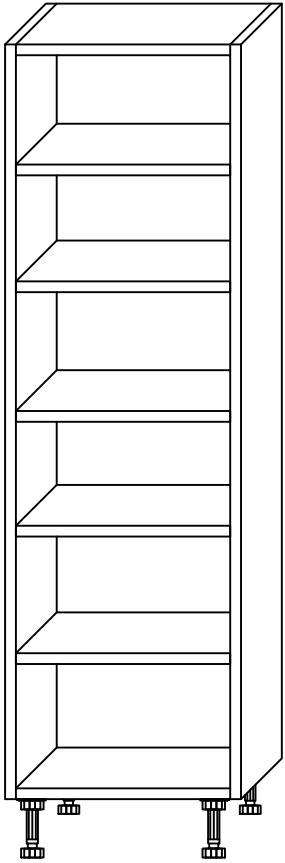

4.

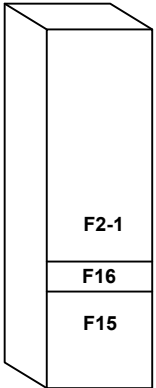
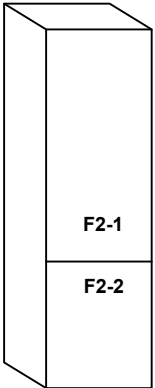

Variant 3.

3.

4.

5.

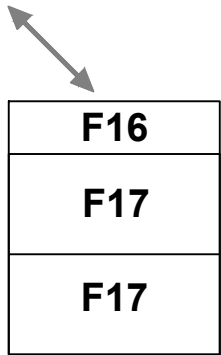
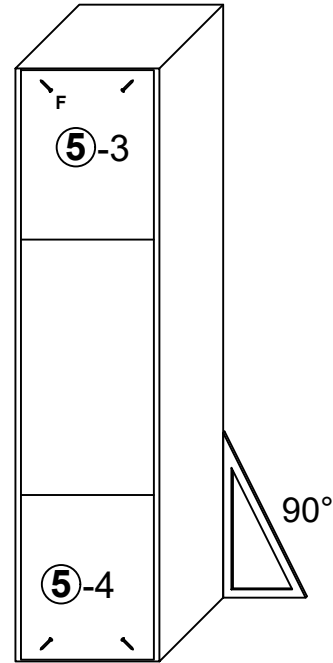
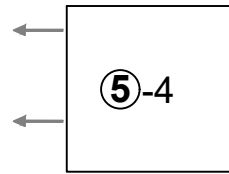
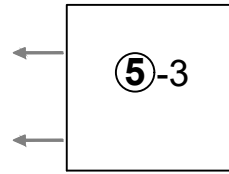
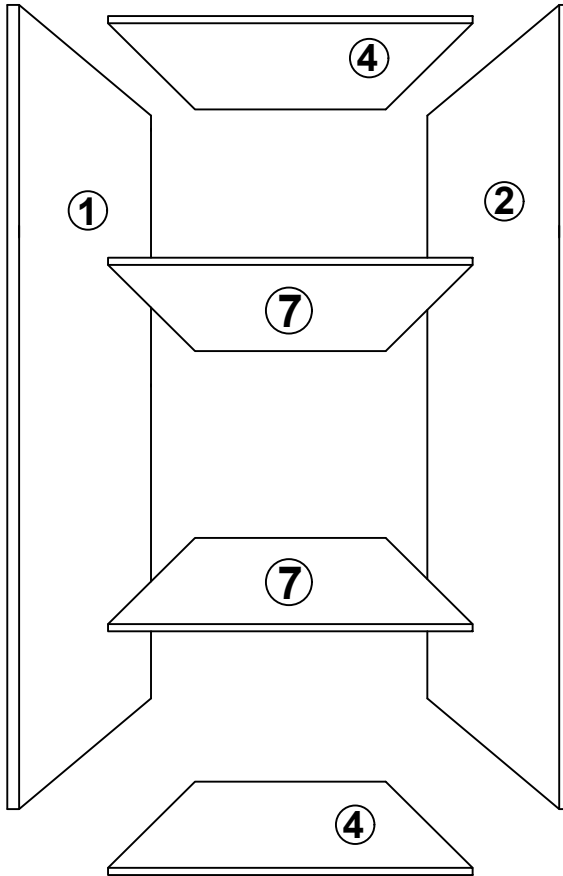
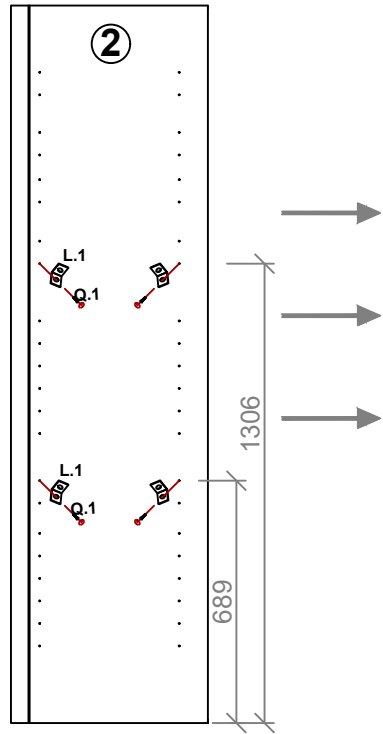
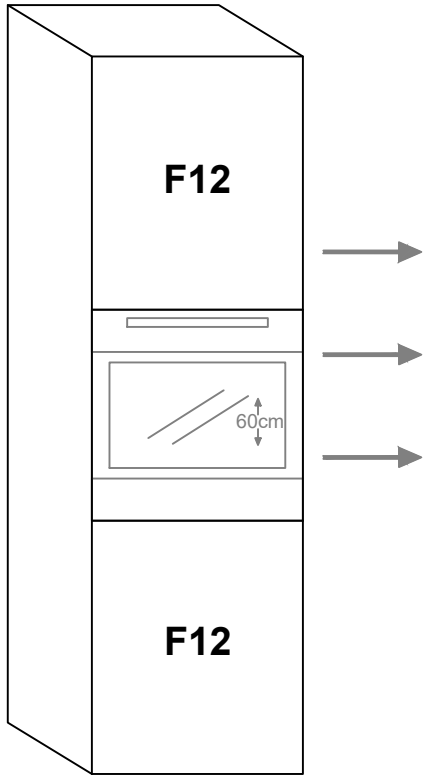

Při použití skřine na vstavanú rúru dílec 5-1, 5-2 nemontovat, kvůli odvětrání.
 Při použití skřine na vestavěnou troubu dílec 5-1, 5-2 nemontovat, kvůli odvětrání.

5.

Variant 4.

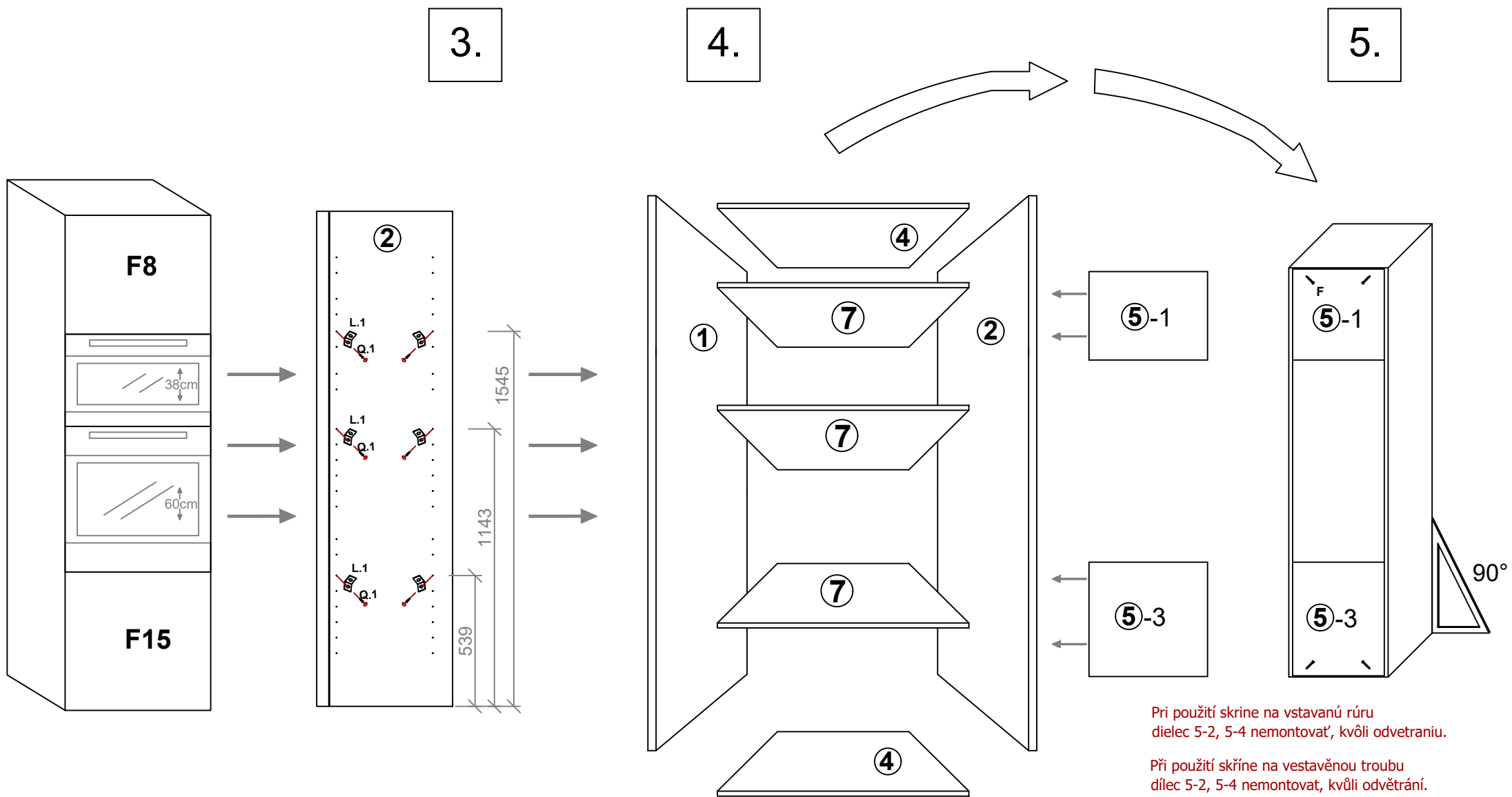

Variant 5.

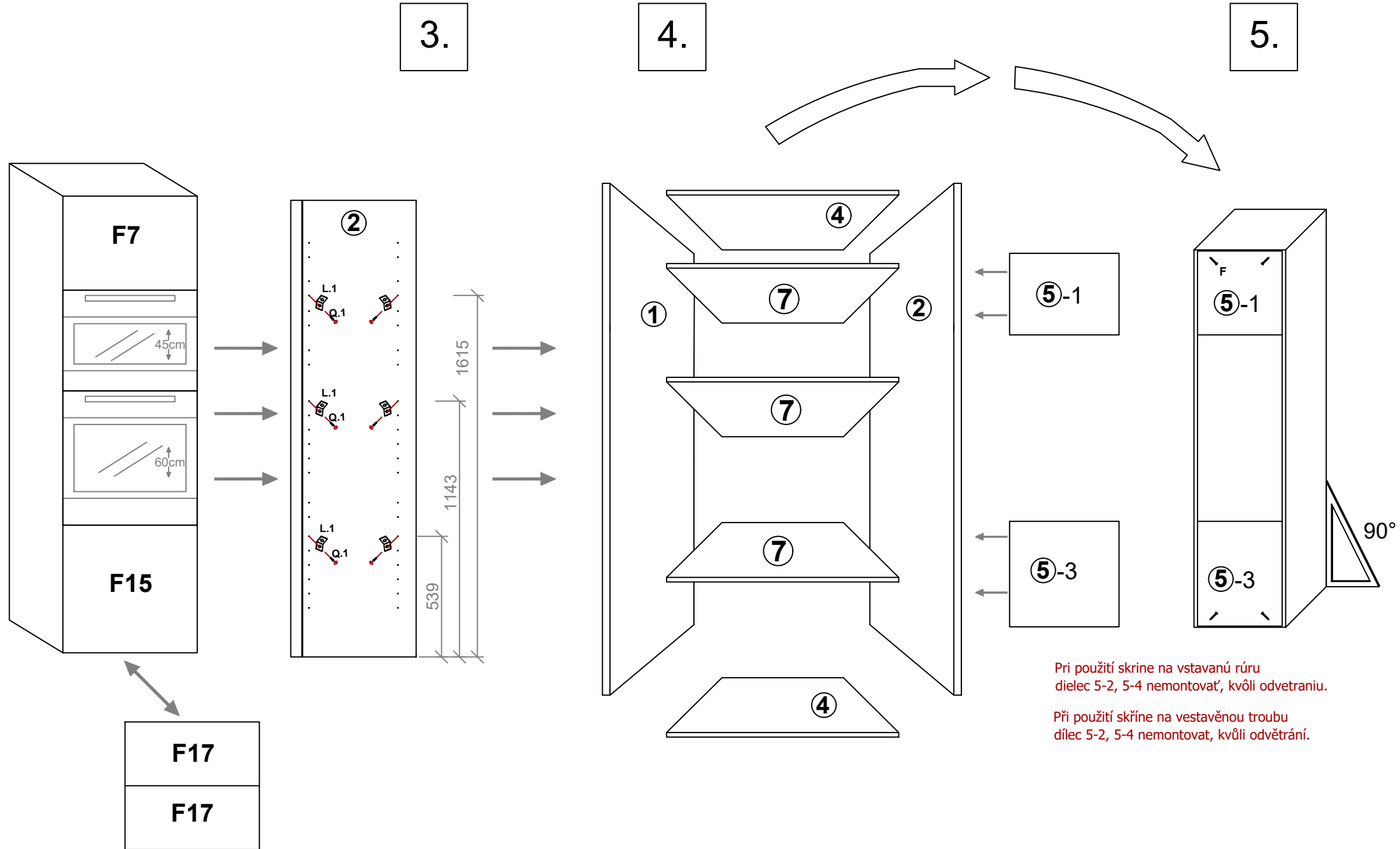

Variant 6.

3.

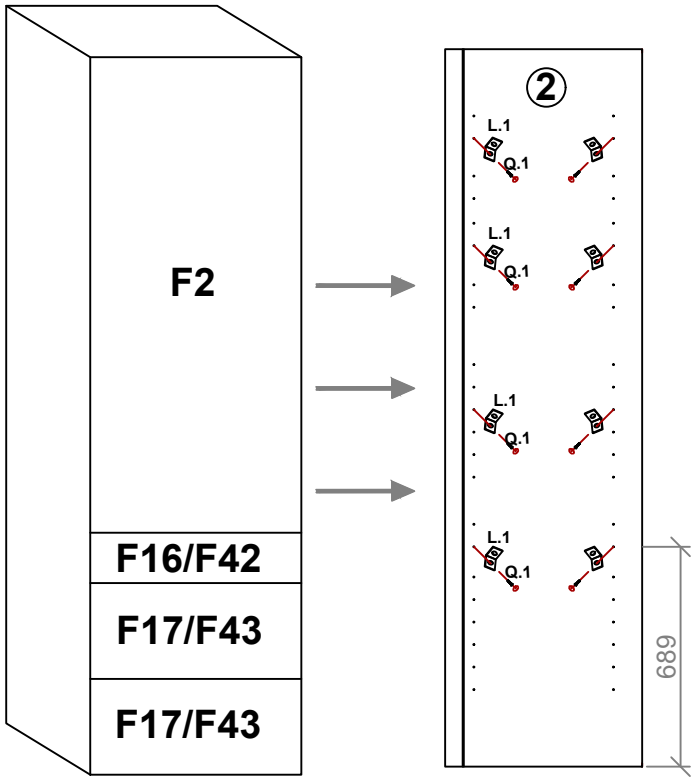

4.

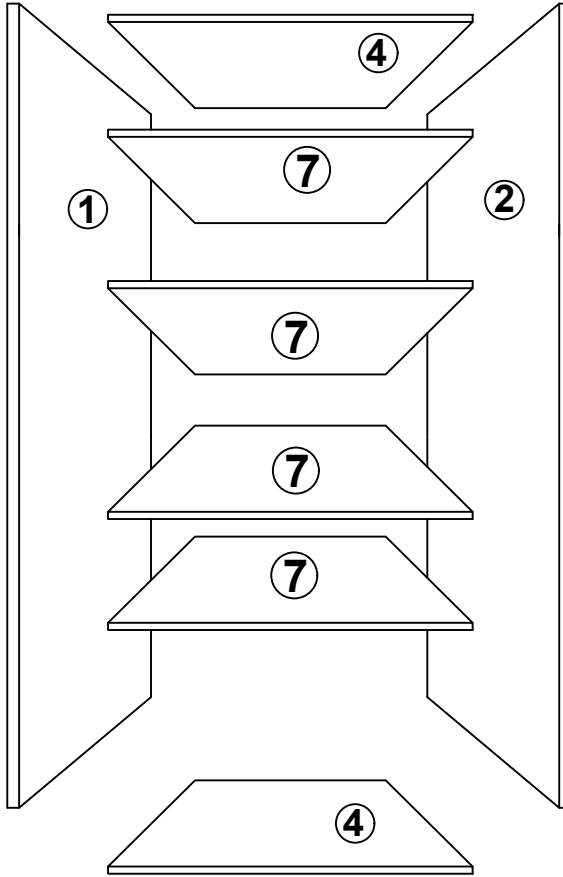

5.

